

## Hardware

(Drawn to Scale)

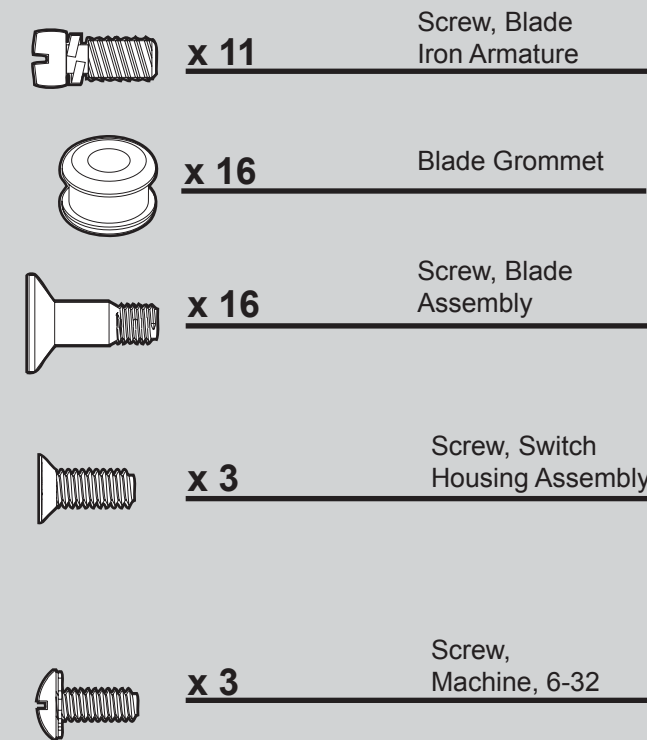
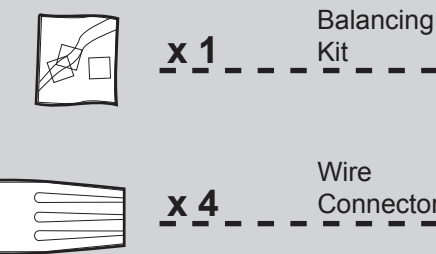
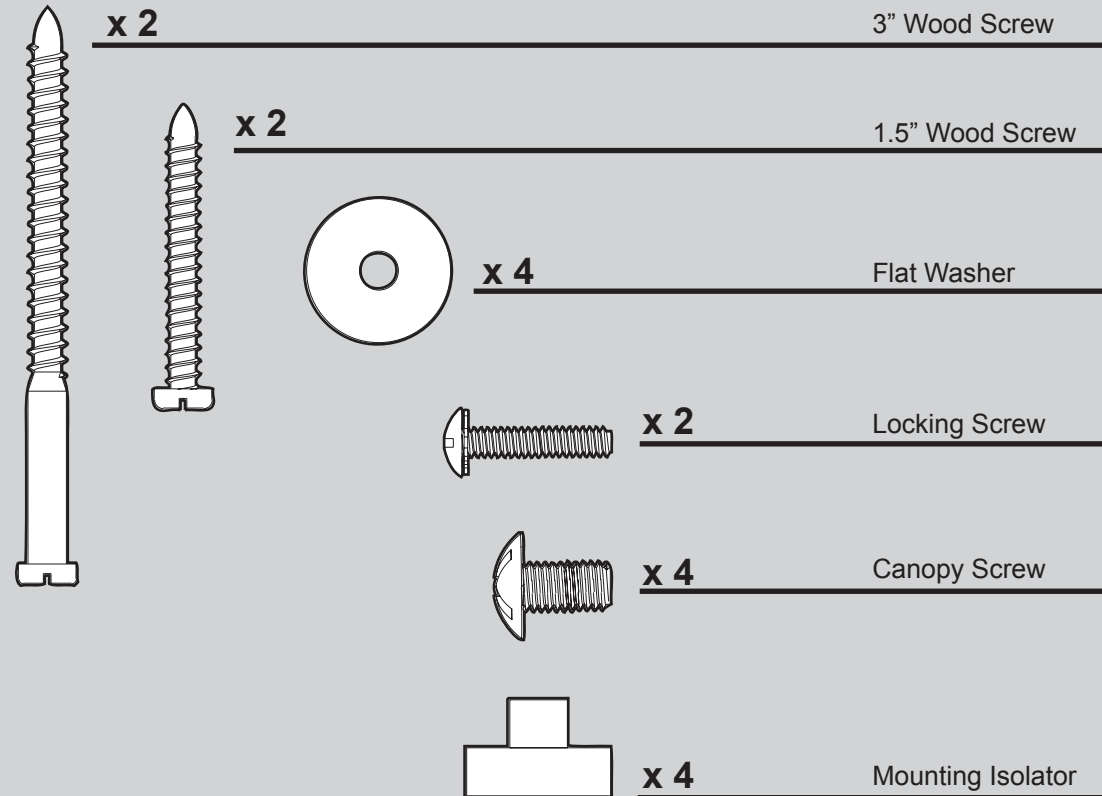

## Fan Parts

(Not Drawn to Scale)

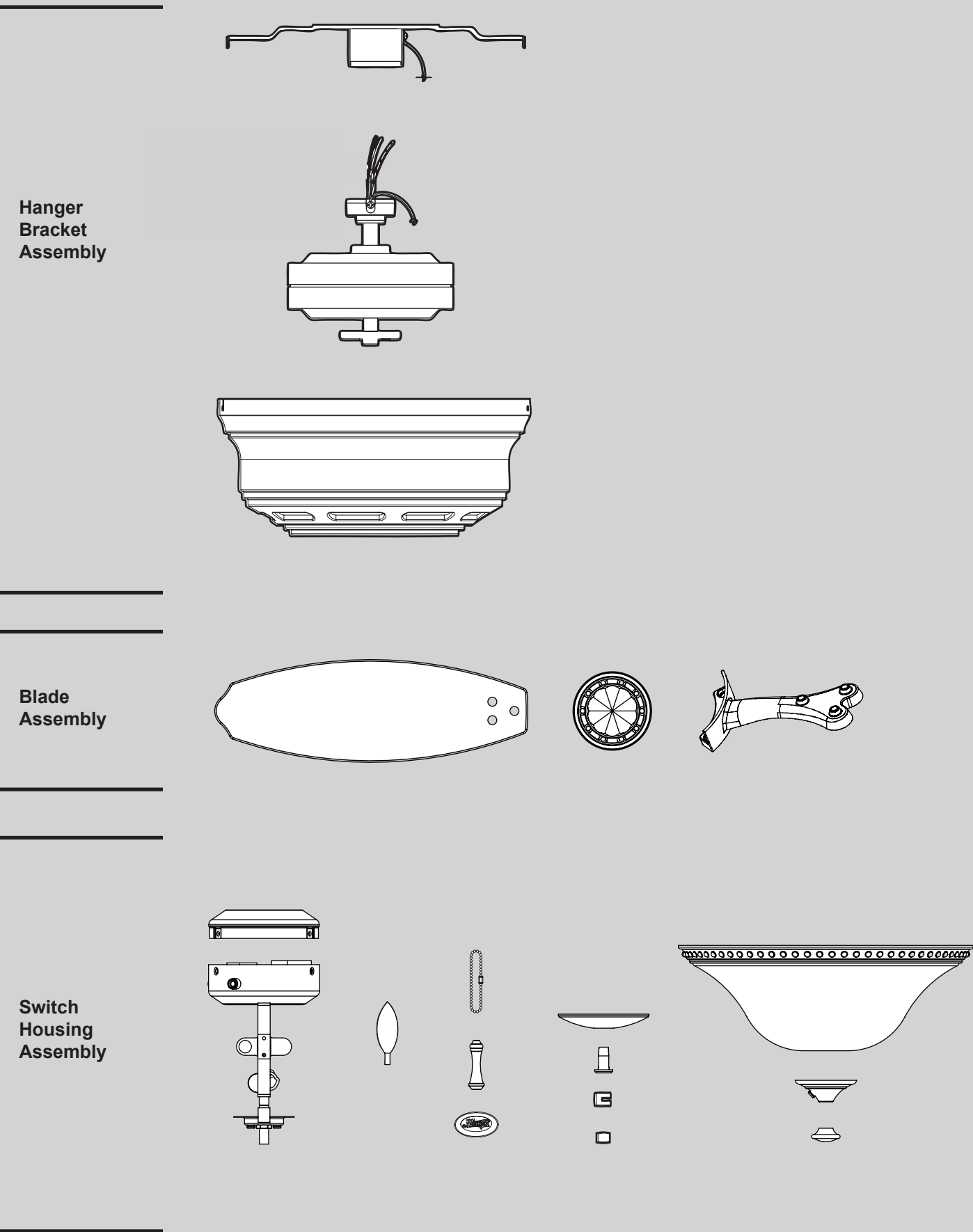

# PARTS GUIDE

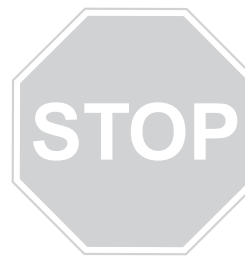

*Hunter*

Using this Parts Guide, make sure all parts are included in the box.

If parts are missing, DO NOT RETURN

THIS ITEM TO THE STORE, call 888-830-1326 for assistance.

THIS PARTS GUIDE IS FOR REFERENCE ONLY.

REFER TO THE INSTALLATION MANUAL FOR FULL ASSEMBLY INSTRUCTIONS.

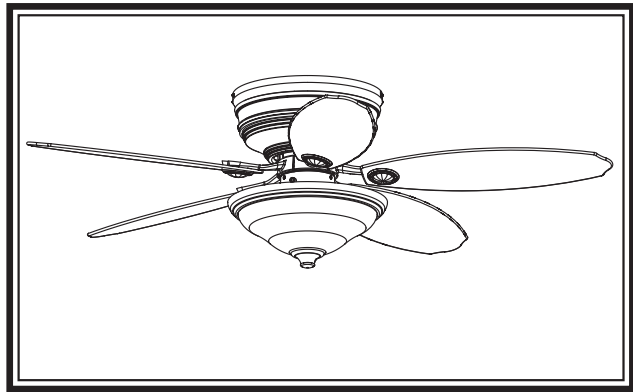

### Parts List

Item Name	Qty	Part #
* Hanger Bracket Assembly	1	73846-01
Switch/Housing Assembly	1	99009-83
Blade Iron Set	1	97327-05
Blade Medallion	5	87498-01
Blade Set	1	75885-81
Screw, Blade Iron Armature	11	63755-05
Globe/Shade	1	87674-01
* Hardware Kit	1	97496-00-860
Wood Screw		
Blade Grommet		
Blade Assembly Screw		
Flat Washer		
Screw, Machine, 6-32		
Wire Connector		
Mounting Isolator		
Machine Screw 8-32		
Pull Chain	2	63756-05
Finial	1	65782-01
Dummy Terminal, Male	1	08198-01
Dummy Terminal, Female	1	08200-01
Cap, Switch housing	1	73853-01
Plug Button	1	73854-01
Fan Pull Chain Pendant	1	74393-08
Light Pull Chain Pendant	1	65399-02
Bulb/Light Bulb	2	77646-04
Motor Cover	1	97497-01
Balancing Kit	1	07570-01

## Materiales

(dibujados a escala)

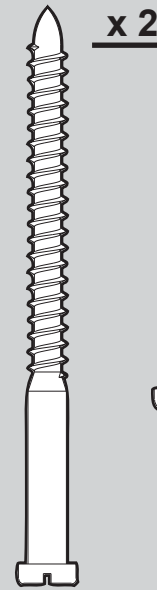

x 2

3" Tornillo, de madera

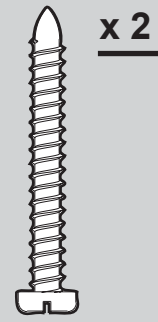

x 2

1.5" Tornillo,  
de madera

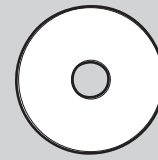

x 4

Arandela, plana

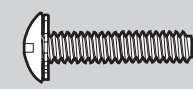

x 2

Tornillo de fijación

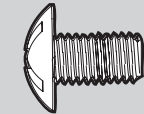

x 4

Tornillo, de campana

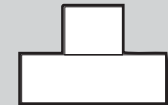

x 4

Aislador de montaje



x 11

Tornillo prisionero

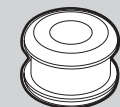

x 16

Tornillo, de armadura  
de soporte de paleta

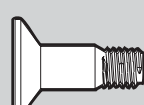

x 16

Tornillo, de conjunto  
de paleta



x 1

Kit de  
equilibrado



x 4

Empalme  
plástico

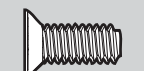

x 3

Tornillo, del conjunto  
de la caja del interruptor

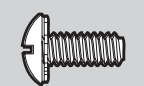

x 3

Tornillo  
mecánico, 6-32

## Piezas del ventilador

(no dibujadas a escala)

Conjunto del  
soporte de  
suspensión

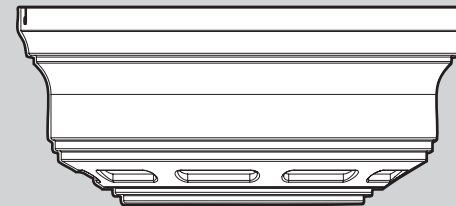
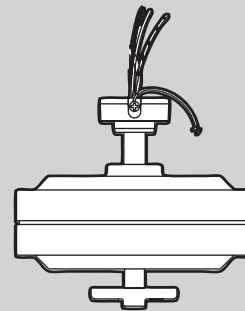
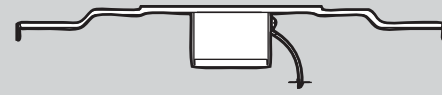

de conjunto  
de paleta

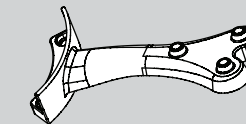
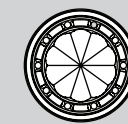
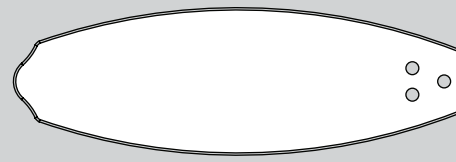

Conjunto del  
interruptor/  
alojamiento

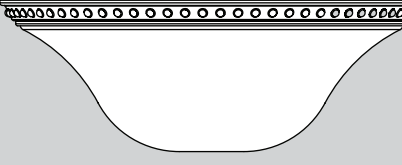
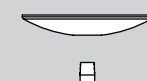
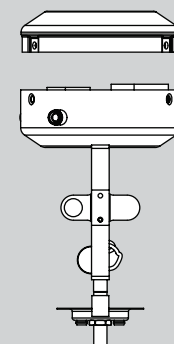

PARADA

*Hunter*

Consulte esta Guía de partes para asegurarse de que todas las partes estén incluidas en la caja.

Si falta alguna parte, NO DEVUELVA ESTE PRODUCTO A LA TIENDA. Solicite ayuda al 888-830-1326. ESTA GUÍA DE PARTES SOLAMENTE ES REFERENCIAL. CONSULTE LAS INSTRUCCIONES COMPLETAS DE ENSAMBLAJE EN EL MANUAL DE INSTALACIÓN

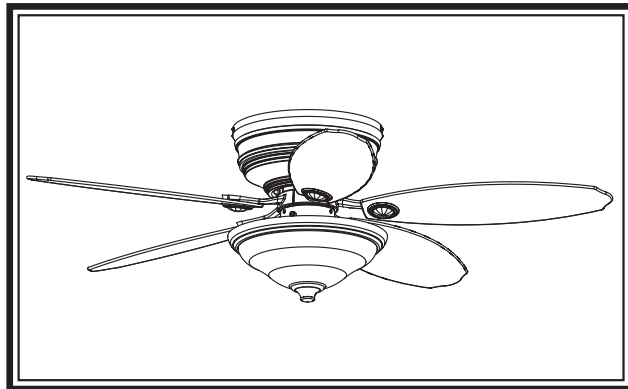

## Lista de piezas

Nombre del ítem	No. del modelo 28419	
	No. del dibujo de ensamblaje	97496-01
	Acabado	Cacao
Nombre del ítem	Cantidad	No. de la pieza
* Conjunto del soporte de suspensión	1	73846-01
Conjunto del interruptor/alojamiento	1	99009-83
Juego de soporte de paletas	1	97327-05
Medallón de la paleta	5	87498-01
Juego de paletas	1	75885-81
Tornillo, de armadura de soporte de paleta	11	63755-05
Globo / Pantalla	1	87674-01
* Kit de materiales	1	97496-00-860
Tornillo, de madera		
Arandela de caucho, de paleta		
Tornillo, de conjunto de paleta		
Arandela, plana		
Tornillo, mecánico, 6-32		
Empalme plástico		
Aislador de montaje		
Tornillo mecánico 8-32		
Tirador de cadena	2	63756-06
Cubierta ornamental	1	65782-01
Terminal simulado, macho	1	08198-01
Terminal simulado, hembra	1	08200-01
Tapa, Caja del interruptor	1	73853-01
Botón taponador	1	73854-01
Pendiente del tirador de cadena del ventilador	1	74393-08
Pendiente del tirador de cadena de luz	1	65399-02
Bombilla	2	77646-04
Cubierta del motor	1	97497-01
Kit de equilibrado	1	07570-01